

Decora® Rocker Slide Controls

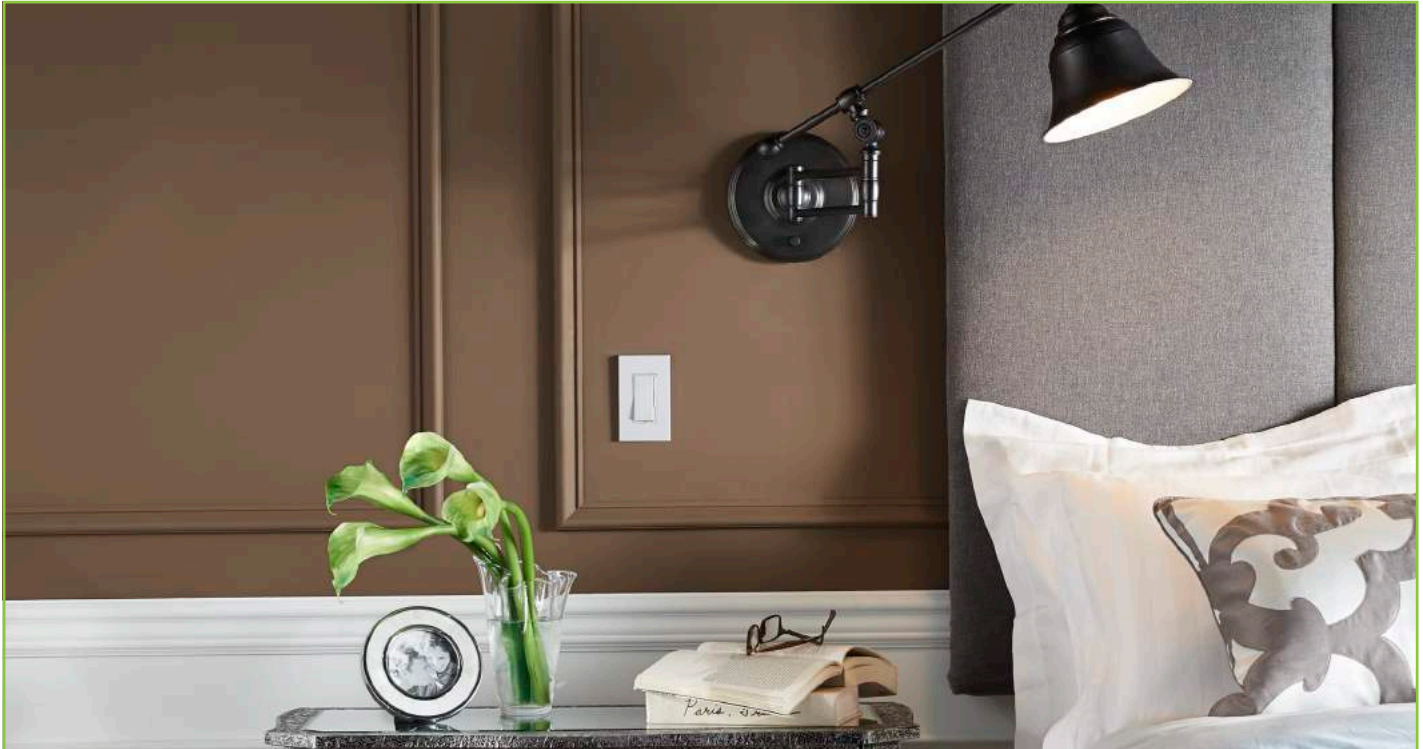

Application

Leviton Decora Rocker Slide Dimmers provide smooth, slide-action, full-range dimming for incandescent, dimmable LEDs, dimmable CFLs, halogen, magnetic low voltage (MLV), electronic low voltage (ELV) and fluorescent loads. The line also includes a Fan Speed Control.

Decora Rocker Slide Controls are designed for both single pole (one location) and 3-way (two location) applications. They feature our hallmark Decora rocker switch that provides preset ON/OFF switching and a smooth, integrated slide bar for fine adjustment of lighting levels. Color change kits simplify inventory by reducing the need for stocking separate devices in every color.

With a new, streamlined style, the Decora dimmers and fan speed control complement any interior design and are compatible with other Decora devices.



FEATURES AND BENEFITS

- New design with rocker switch and slender dimmer control slide bar
- Integrated linear full-range slide control for easy, precise operation
- Separate ON/OFF switch that preserves the selected brightness setting
- Provides single pole (one location) or 3-way (two location) lighting control when paired with a 3-way switch
- Comes packaged in White with Ivory and Light Almond color change kits
- Additional color change kits available in Black, Brown, Red and Gray
- Slim, compact housing fits easily into a standard wallbox
- Suitable for multi-gang installations with other Decora products
- No fins for multi-gang installation
- Built-in radio/TV interference filter

LED/CFL/Incandescent/Halogen Dimmers

- DSL06 and DSM10 designed for optimal control of dimmable LED and CFL lamps

- DSM10 also compatible with Magnetic Low Voltage lamps
- Microprocessor control offers flexibility to fine-tune LEDs and CFLs for best performance (DSL06 and DSM10)
- Setting available for ensuring start up for CFL lamps
- Wider dimming range on LED and CFL lamps than conventional incandescent dimmers
- Optional programming feature allows users to modify the dimming range to optimize low light level performance when required
- Locator light can be enabled or disabled

0-10V LED/Mark 7® Fluorescent Dimmer

- DS710 designed for use with LED fixtures using 0-10V power supplies
- Dual voltage 120V/277V
- No power pack required for switching
- 50ma 0-10V “Sinking” current available

Quiet Fan Speed Control

- 1.5 Amps of quiet fan speed control
- Combines a Decora rocker ON/OFF switch with a contemporary slender slide bar for the selection of low, medium or high fan speeds
- Ideal for libraries, home offices, bedrooms and any area where ceiling fan noise could become distracting

SPECIFICATIONS AT-A-GLANCE

	DSL06	DSM10	DSF01	DSE06	DS710	DSX10	DSX12	DSH08-1	DSH06-7
Voltage, Frequency									
120VAC-60Hz	Yes	Yes	Yes	Yes	Yes	Yes	-	Yes	-
277VAC-60Hz	-	-	-	-	Yes	-	Yes	-	Yes
Load Rating									
Incandescent/ Halogen	600W	1000W	-	-	-	-	-	-	-
LED/CFL	300W	450W	-	300W	-	-	-	-	-
MLV	-	1000VA	-	-	-	-	-	-	-
ELV	-	-	-	600VA	-	-	-	-	-
Fluorescent	-	-	-	-	1200VA 1500VA	1000VA	1200VA	8A	6A
Motor	-	-	1.5A	-	-	-	-	-	-
Mechanical									
Neutral Required	No	No	No	Yes	No	No	No	Yes	Yes
Single Pole/3-Way	Yes	Yes	Yes	Yes	Yes	Yes	Yes	Yes	Yes
Locator Light	Yes	Yes	No	No	No	No	No	No	No

TYPICAL SPECIFICATIONS

Operating Temperature Range - 0°C to 55°C
 Storage Temperature Range - -10°C to 85°C
 Relative Humidity – 20% to 90% Non-Condensing

AGENCY STANDARDS AND COMPLIANCE

Dimmers

- cCSAus Certified to Standard 184.1
- Complies with UL 1472
- NOM

Fan Speed Control

- cCSAus Certified to C22.2 No. 156
- Complies with UL 1917
- NOM

WARRANTY INFORMATION

Five-Year Limited Warranty

INSTALLATION CONSIDERATIONS

Note: Sharing a neutral wire may cause flickering. Connect all devices to the same phase or run a separate neutral to each phase. Consult Leviton Tech Line if problems persist.

Warning: To avoid fire, shock or death when retrofitting Mark 10 Powerline dimming ballasts into fixtures that originally had Instant Start ballasts, the sockets MUST be replaced with Rapid Start sockets to allow proper dimmer operation and prevent property damage, injury or death. Refer to the instructions provided with the ballast and the Leviton dimmer.

DSL06 and DSM10: LED and CFL lamps marked or rated as dimmable can be used with this dimmer. For a complete list of approved LED and CFL lamps visit www.leviton.com/universal

Use Leviton Power Extenders to extend the load capacity of box mounted dimmers. Leviton Power Extenders are available for incandescent, magnetic low voltage, electronic low voltage, Mark 10 Powerline fluorescent dimming ballasts or equivalents and 0-10 VDC dimmable fluorescent ballasts such as Mark 7 0-10V, OSRAM Sylvania Quicktronic® Helios™ or equivalent ballasts.

MAXIMUM LOAD FOR MULTI-GANG APPLICATIONS

In multi-gang applications de-rating may be required in accordance with the following chart.

Maximum Load for Multi-Gang Applications			
Cat. No.	Single	2-gang	3-gang or more
DSL06	600W Incandescent 300W (2.5A) LED/CFL	500W Incandescent 300W (2.5A) LED/CFL	500W Incandescent 300W (2.5A) LED/CFL
DSM10	1000W Incandescent 1000VA MLV 450W (3.75A) LED/CFL	800W Incandescent 800VA MLV 450W (3.75A) LED/CFL	700W Incandescent 700VA MLV 450W (3.75A) LED/CFL
DSF01	1.5A	1.5A	1.5A
DSE06	480W (4A)	480W (4A)	480W (4A)
DS710 (120V)	960W	960W	960W
DS710 (277V)	1200W	1200W	1200W
DSX10	800W	800W	800W
DSX12	960W	960W	960W
DSH06-7	6A	6A	6A
DSH08-1	8A	8A </td <td>8A</td>	8A

DIMENSIONAL DRAWINGS

Cat. No. DSL06

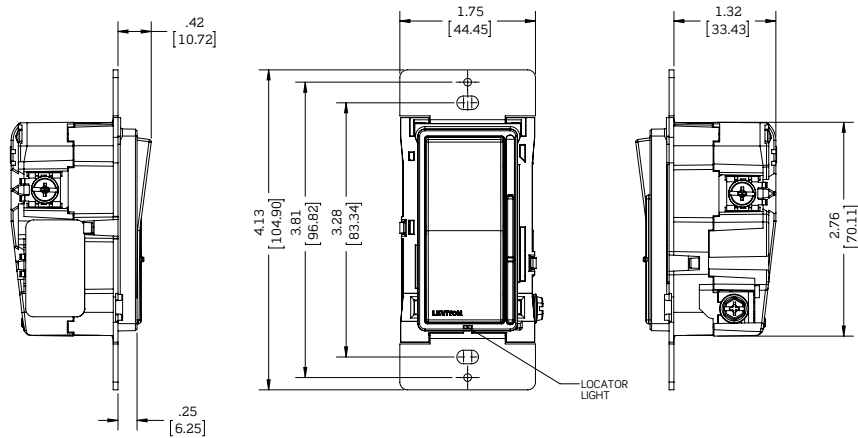

Cat. No. DSM10*, DSF01, DSE06, DS710, DSX10, DSH06 & DSH08

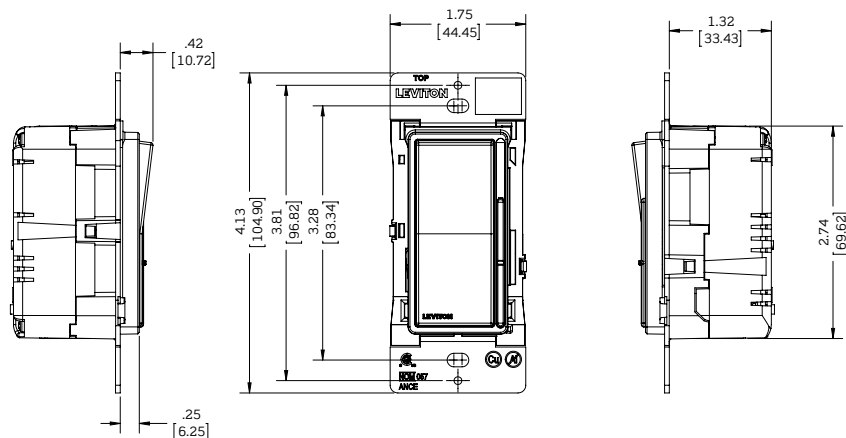

* has a locator light

WIRING DIAGRAMS

Cat. No. DSL06 & DSM10 Universal Dimmers

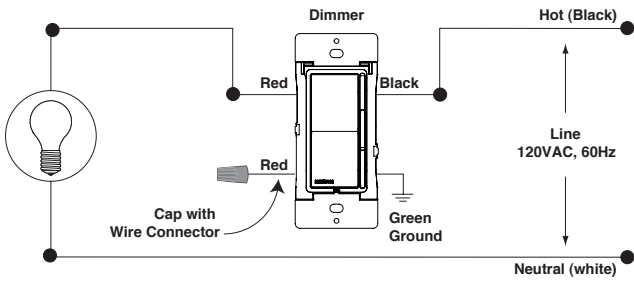

Single Pole

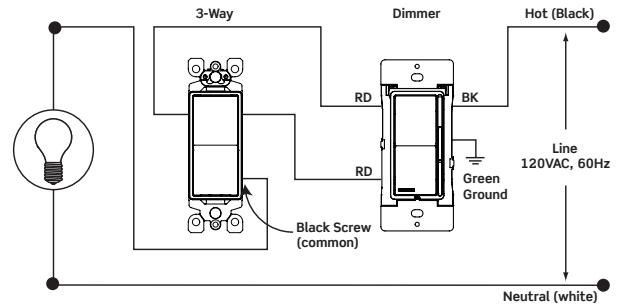

3-Way

Cat. No. DSF01 Fan Speed Control

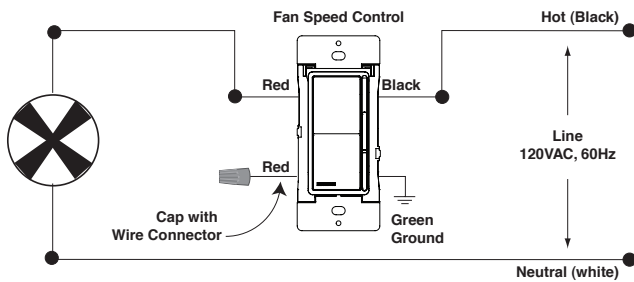

Single Pole

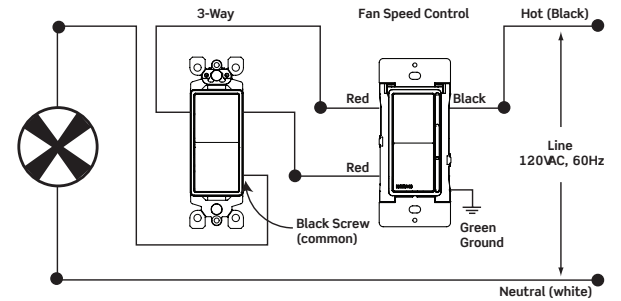

3-Way

Cat. No. DSE06 Electronic Low Voltage Dimmer

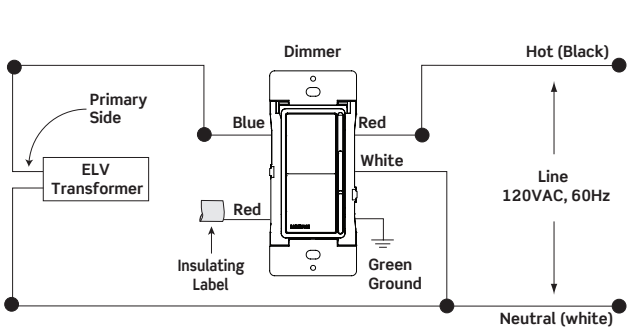

Single Pole

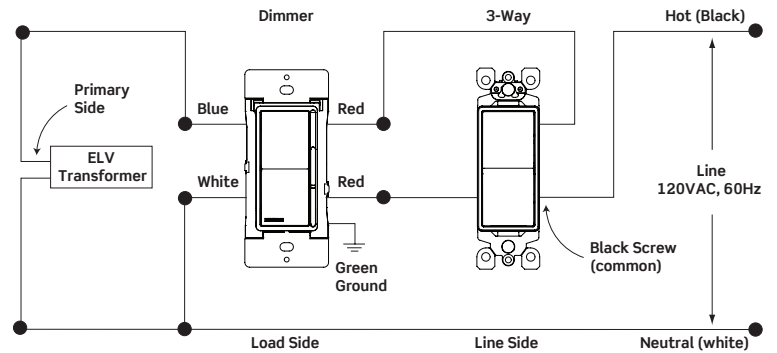

3-Way

WIRING DIAGRAMS

Cat. No. DS710 0-10V LED/Mark 7[®] Fluorescent Dimmer

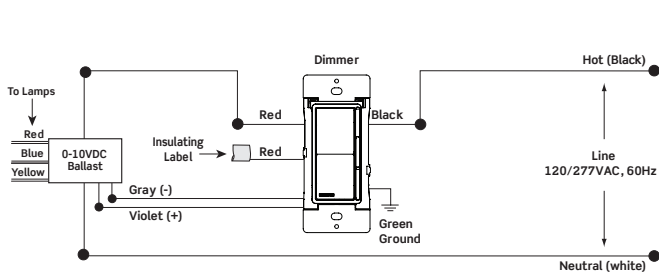

Single Pole

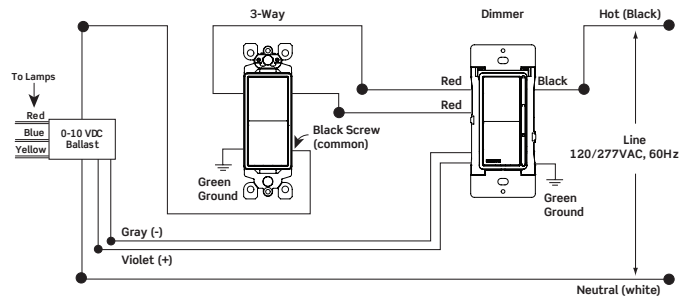

3-Way

Cat. No. DSX10 & DSX12 Mark 10[®] Powerline Fluorescent Dimmers

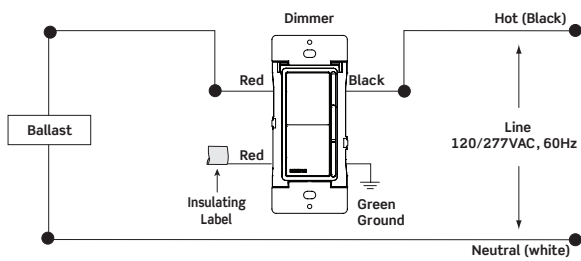

Single Pole

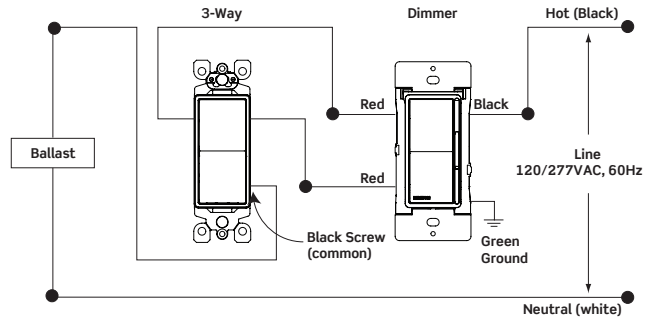

3-Way

Cat. No. DSH06 & DSH08 Fluorescent Dimmers

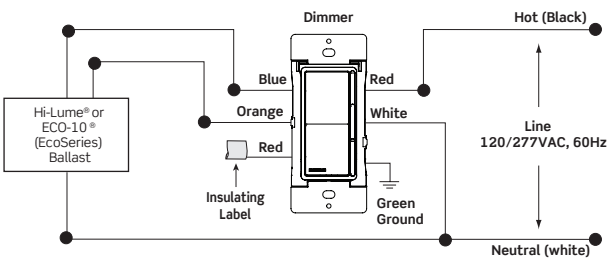

Single Pole

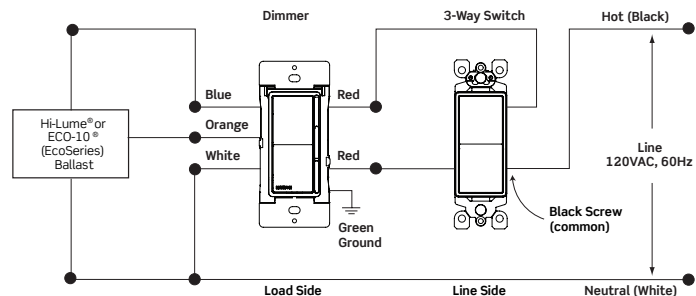

3-Way

ORDERING INFORMATION

Cat. No.	Description	Rating	Color
DSL06	Incandescent, LED, CFL dimmer with locator light	600W Incandescent 300W LED/CFL	Z
DSM10	Incandescent, MLV, LED, CFL dimmer with locator light	1000W Incandescent/MLV 450W LED/CFL	Z
DSF01	Quiet Fan Speed Control	1.5A	Z
DSE06	Electronic Low Voltage Dimmer (Trailing Edge), No locator light, neutral required	600VA ELV 300VA LED/CFL	Z
DS710	Mark 7® Fluorescent ballast and LED Power Supply 0-10V dimmers, No locator light	1200VA @120VAC 1500VA @ 277VAC	Z
DSX10	Mark 10® <i>Powerline</i> Fluorescent Dimmer, No locator light	1000VA @ 120VAC	Z
DSX12	Mark 10® <i>Powerline</i> Fluorescent Dimmer, No locator light	1200VA @ 277VAC	Z
DSH06-7	Fluorescent dimmer for Hi-Lume® or Eco-10® type ballasts, No locator light	6A @ 277VAC	Z
DSH08-1	Fluorescent dimmer for Hi-Lume® or Eco-10® type ballasts, No locator light	8A @120VAC	Z

COLOR CHANGE KITS

Description	Cat. No.	Color
Snap-on frame with slide bar and rocker, locator light in frame	DSKIT-00	W, I, T, G, E, B, R
Snap-on frame with slide bar and rocker, no locator light	DSKIT-0N	W, I, T, G, E, B, R

Decora Rocker Slide controls come packaged with three colors. Products with suffix (-Z) include White, Ivory and Light Almond. Color Change Kits are available in the following colors: White (-W), Ivory (-I), Light Almond (-T), Gray (-G), Black (-E), Brown (-B) and Red (-R).

Third party trademarks used herein are the property of their respective owners and are used for identification/reference purposes only.

Leviton Manufacturing Co., Inc. World Headquarters

201 North Service Road, Melville, NY 11747-3138
 Telephone: 1-800-323-8920 FAX: 1-800-832-9538
 Tech Line (8:30AM-7:00PM E.T. Monday-Friday): 1-800-824-3005

Visit our Website at: www.leviton.com

© 2015 Leviton Manufacturing Co., Inc. All rights reserved.
 All trademarks are the property of their respective owners.

Follow us on:

